

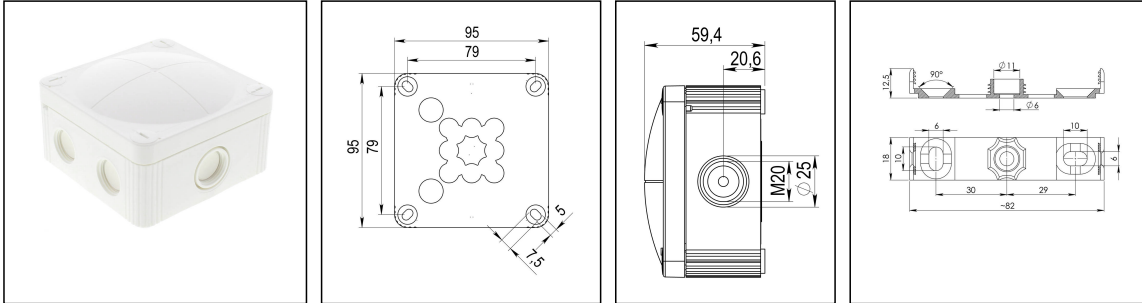

## COMBI 407 WH

Junction box 95x95x60mm, polypropylene, RAL 9001



Products may differ in size, colour and appearance to those shown. If you require further information or customisation, please contact us directly.



<b>Material</b>	Polypropylene
<b>Material sealing gasket</b>	TPE
<b>Temp. range min</b>	-30 °C
<b>Temp. range max</b>	100 °C
<b>Temperatures during install.</b>	-5 °C - 60 °C
<b>Protection class</b>	IP66 / IP67
<b>Glow wire test</b>	750 °C
<b>Voltage</b>	690 V
<b>Rated cross section</b>	4 mm <sup>2</sup>
<b>Fixing</b>	4 internal openings
<b>Ø cable diameter min</b>	3 mm
<b>Ø cable diameter max</b>	12 mm
<b>External dimensions LxWxH</b>	95 x 95 x 60mm
<b>Type of cable gland</b>	M 20 x 1,5, M 25 x 1,5
<b>Using for cable gland</b>	
<b>Product Color</b>	RAL 9001
<b>WISKA-Order no.</b>	10105598
<b>Type</b>	COMBI 407 WH
<b>Packing unit</b>	5
<b>ETIM-Classification</b>	EC002600
<b>EAN number</b>	4007686010824
<b>Tariff number</b>	39269097

Remarks:

IP66: using the membrane entry

Your Contact:

**WISKA Hoppmann GmbH**  
Kisdorfer Weg 28 · 24568 Kaltenkirchen · Germany  
☎ +49-4191-508-0 · 📠 +49-4191-508-209  
contact@wiska.de · www.wiska.com

**IP67: using the threaded entry together with ESKV cable gland**

**Equipment:**

- 6x M20 threaded membrane entries and 1 middle M20 threaded membrane entry with knockout to M25
- 2 membrane cable entries through rear
- 4 captive cover screws
- including mounting clip

**Fixing:**

With mounting clip or 4 internal openings outside of the sealing area

**Recommended accessories**

DIN Rail Kit - COMBI 407/TS 15	10105604
DIN Rail Kit - COMBI 407/TS 35	10105605
MP-S Mounting plate small	10105774
MP-L Mounting plate large COMBI / WHK	10105775
External mounting - COMBI LG	10108836
ZER 4-12 LG	10109800
SP-KT-W 221/CSM-3x221-413	22001114
SP-KT-W 221/CSM	22001115
SP-HKT 11/5 Terminal block	22001132

09.08.2023

Your Contact:

**WISKA Hoppmann GmbH**

Kisdorfer Weg 28 · 24568 Kaltenkirchen · Germany

☎ +49-4191-508-0 · 📠 +49-4191-508-209

contact@wiska.de · www.wiska.com



Your Contact:

**WISKA Hoppmann GmbH**

Kisdorfer Weg 28 · 24568 Kaltenkirchen · Germany

☎ +49-4191-508-0 · 📠 +49-4191-508-209

contact@wiska.de · www.wiska.com



Your Contact:

**WISKA Hoppmann GmbH**

Kisdorfer Weg 28 · 24568 Kaltenkirchen · Germany

☎ +49-4191-508-0 · 📠 +49-4191-508-209

contact@wiska.de · www.wiska.com